

Jedoniañ

V/oct to Hz/V & Hz/V to V/oct converter
and their respective S-trig/V-trig

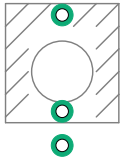



Stereo Jack

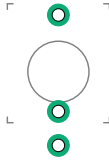

Mono Jack

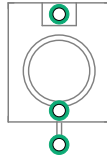

Mono Jack

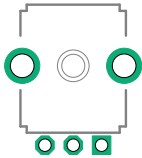

Mono Pot

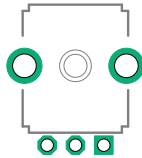

Stereo Pot

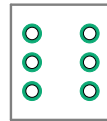

Switch DPDT

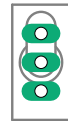

Switch SPDT

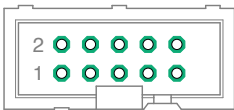

Power Socket



Power Pin Header



Resistor



Capacitor



Diode



Led 3mm



Trimmer



Transistor

TOP

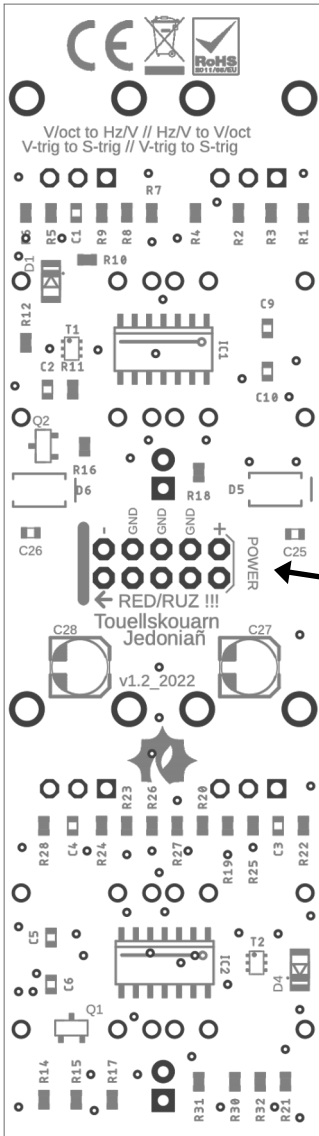

POWER.....2X5 Pin Header



BOTTOM

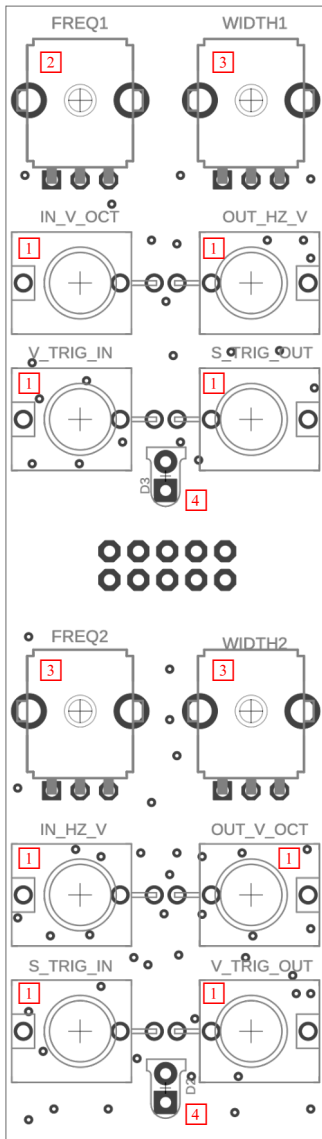

Soldering order

- 1 8 X Mono Jacks
- 2 1 X 100kB potentiometers
- 3 3X 10kB potentiometers

Place the 2 leds without soldering them, then install the panel and put the nuts on the jacks. Adjust the led in the holes on the faceplate and solder them in place.

- 4 2 X Red Leds 3mm



Long Leg of the Led in the Square Hole

